

# Data Sheet



Article number: 12621000040000

Description: Industrial tool 621 000 040.000  
For M4

## Measures

---

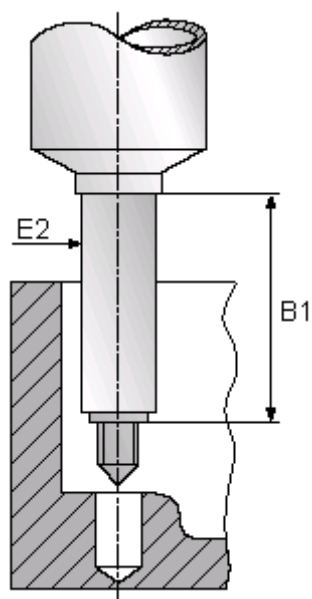

B1 = 40

E2 = 7

For thread = M4